

# DISPLAY CONTROL SWITCH

Swiss based Trafag is a leading international supplier of high quality sensors and monitoring instruments for measurement of pressure and temperature.



## Applications

- Shipbuilding
- Machine tools
- Hydraulics
- Process technology

## Features

- Simple adjustment of switching points
- Back-lit LCD-Display
- Measurement and indication of pressure (incl. switch state) and sensor temperature in various units
- High resistance to pressure cycling
- Output signal 2 relays, electrically isolated

06/2015

Data sheet H72605k

Technical Data			
Measuring principle	Thin film on steel	Media temperature	-25°C ... +125°C
Measuring range	0 ... 1 to 0 ... 600 bar	Ambient temperature	-25°C ... +80°C (LCD display active -10 ... 70°C)
Output signal	4...20 mA, 0...10 VDC 2 Relays, electrically isolated 30W (max. 1A), 36 VAC/ DC	Approval	GL
Accuracy @ 25°C typ.	± 0.5 % FS typ.		

Subject to change

## Ordering information/type code

				8864 . XX	XX	XX	XX	XX	XX
<b>Measuring range <sup>1)</sup></b>	<b>Pressure measurement range</b>	<b>Over pressure</b>	<b>Burst pressure</b>						
	[bar]	[bar]	[bar]						
	0 ... 1	2	30	71					
	0 ... 2.5	5	100	75					
	0 ... 4	8	100	76					
	0 ... 6	12	100	77					
	0 ... 10	20	200	78					
	0 ... 16	32	200	79					
	0 ... 25	50	300	80					
	0 ... 40	80	300	81					
	0 ... 60	120	500	82					
	0 ... 100	200	500	83					
	0 ... 250	500	1000	74					
	0 ... 400	800	1500	84					
0 ... 600	1200	2000	86						
<b>Sensor</b>	Relative pressure				23				
<b>Pressure connection</b>	G1/4" male (Seal DIN3869 and pressure peak damping element)					15			
	G1/4" male (Seal DIN3869)					17			
	G1/4" female					10			
	G1/2" male DIN16288-B (Manometer)					11			
	Flange connection					41			
<b>Electrical connection</b>	Male electrical plug M12x1, 8-pol.						38		
<b>Output</b>	<b>Output</b>	<b>Load resistance</b>	<b>U (supply)</b>						
	4 ... 20mA	≤ 250W	11 ... 32 VDC					19	
	0 ... 10 VDC	≥ 5.0 kW	15 ... 30 VDC					17	
<b>Accessories</b>	2 Relay								23
	Female electrical connector: M12x1, 8-pol., incl. 2m PUR-cable								
	Ordering code: DCS CON								

<sup>1)</sup> Customized pressure ranges upon request

Standard products (extra short lead time)					
Product No.	Type Code	Pressure range [bar]	Over pressure max. [bar]	Signal output	Accuracy @ 25°C typ. [%]
DCS2.5AR	8864 75 2315 38 0000 0000 19 23	0...2.5	6	4...20 mA; 2 relays 30 W (max. 1 A)/36 VAC/DC	±0.5
DCS4.0AR	8864 76 2315 38 0000 0000 19 23	0...4	10	4...20 mA; 2 relays 30 W (max. 1 A)/36 VAC/DC	±0.5
DCS6.0AR	8864 77 2315 38 0000 0000 19 23	0...6	15	4...20 mA; 2 relays 30 W (max. 1 A)/36 VAC/DC	±0.5
DCS10.0AR	8864 78 2315 38 0000 0000 19 23	0...10	20	4...20 mA; 2 relays 30 W (max. 1 A)/36 VAC/DC	±0.5
DCS16.0AR	8864 79 2315 38 0000 0000 19 23	0...16	32	4...20 mA; 2 relays 30 W (max. 1 A)/36 VAC/DC	±0.5
DCS25.0AR	8864 80 2315 38 0000 0000 19 23	0...25	80	4...20 mA; 2 relays 30 W (max. 1 A)/36 VAC/DC	±0.5
DCS40.0AR	8864 81 2315 38 0000 0000 19 23	0...40	80	4...20 mA; 2 relays 30 W (max. 1 A)/36 VAC/DC	±0.5
DCS100.0AR	8864 83 2315 38 0000 0000 19 23	0...100	200	4...20 mA; 2 relays 30 W (max. 1 A)/36 VAC/DC	±0.5
DCS250.0AR	8864 74 2315 38 0000 0000 19 23	0...250	500	4...20 mA; 2 relays 30 W (max. 1 A)/36 VAC/DC	±0.5

#### Additional information

##### Documents

Data sheet	<a href="http://www.trafag.com/H72605">www.trafag.com/H72605</a>
Instructions	<a href="http://www.trafag.com/H73605">www.trafag.com/H73605</a>
Flyer	<a href="http://www.trafag.com/H70676">www.trafag.com/H70676</a>

Specifications		
<b>Accuracy</b>	TEB typ. @ -25 ... +85°C	± 1.0 % FS typ.
	Accuracy @ 25°C typ.	± 0.5 % FS typ.
	NLH @ 25°C (BSL) typ.	± 0.25% FS typ.
	TC zero point and span typ.	± 0.01% FS/K typ.
	Long term stability 1 year typ.	± 0.2 % FS typ.
	Sensor temperature	± 2.5°C
<b>Electrical Data</b>	Current consumption	< 70 mA
	Output / supply voltage	4 ... 20 mA: 24 (11 ... 32) VDC 0 ... 10 VDC: 24 (15 ... 30) VDC
	Rise time	typ. 1 ms/ 10...90 % Nominal pressure
<b>Environmental conditions</b>	Media temperature	-25°C ... +125°C
	Ambient temperature	-25°C ... +80°C (LCD display active -10 ... 70°C)
	Protection <sup>1)</sup>	IP65
	Humidity	Max. 95 % relative
	Vibration	10g (25...2000 Hz)
	Shock	50g/ 1 ms
<b>EMC Protection</b>	Emission	EN/IEC 61000-6-3
	Immunity	EN/IEC 61000-6-2
<b>Mechanical Data</b>	Sensor	1.4542 (AISI630)
	Housing / Pressure connection	1.4301/1.4306 (AISI304/304L)
	Sealing	NBR 70 Sh
	Male electrical plug	8-pole (PA) U <sub>max</sub> : 30 VAC/ 36 VDC
	Weight	~ 200 g
	Mounting torque	25 Nm

<sup>1)</sup> Provided female connector is mounted according to instructions

Display	
LCD display	Back-lit
4 Digits resolution	≤ 0.2% FS
Indication range	-5 ... 125% FS
Operation	Menu selection with 2 buttons
Adjustment of parameters	See dimensions

Relay output	
Output	2 Relays, electrically isolated 30W (max.1A), 36 VAC / DC
Switching time	5...9999 ms, adjustable
Switching differential	typ. 1...99% FS

## Dimensions

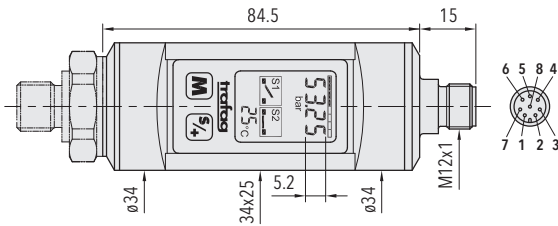

8864.XX.23XX.XX.XX.XX

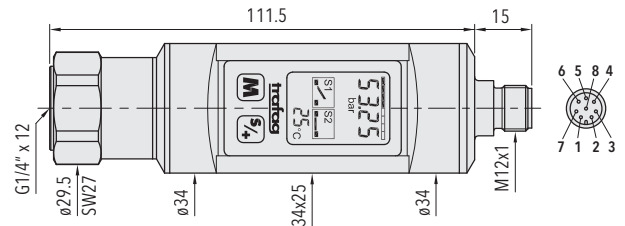

8864.XX.2310.XX.XX.XX

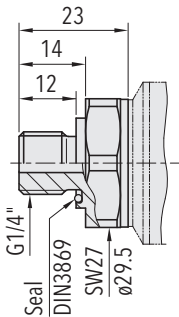

8864.XX.2317.XX.XX.XX

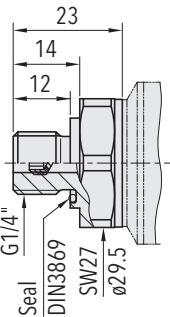

8864.XX.2315.XX.XX.XX

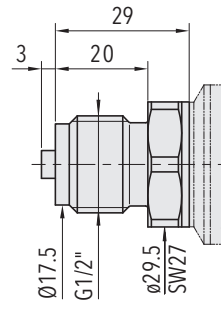

8864.XX.2311.XX.XX.XX

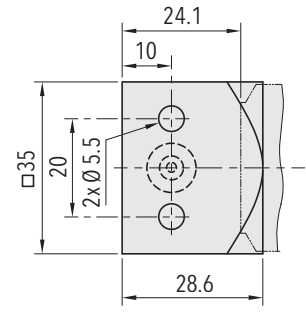

8864.XX.2341.XX.XX.XX

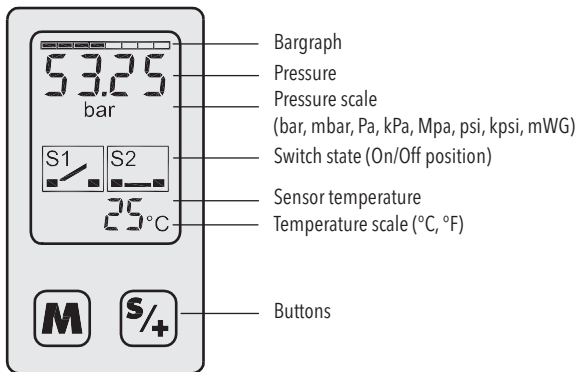

Adjustment parameters

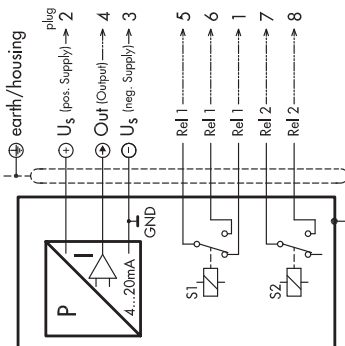

4 ... 20 mA/ 2 relays  
8864.XX.XXXX.XX.19.23

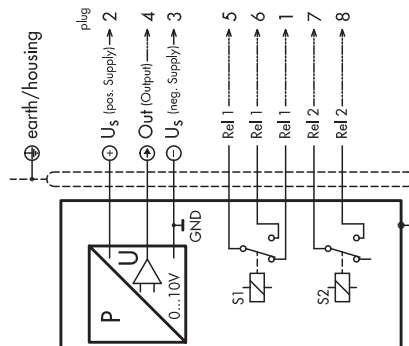

0 ... 10 VDC/ 2 Relays  
8864.XX.XXXX.XX.17.23

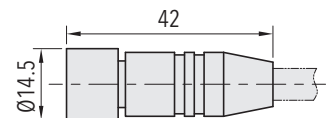

### DCS CON

Cable length 2 m  
Cable material PUR  
Shield on screw

- |            |          |
|------------|----------|
| 1 = white  | 5 = grey |
| 2 = brown  | 6 = pink |
| 3 = green  | 7 = blue |
| 4 = yellow | 8 = red  |