

TECHNOPOOL 3



(SONDA PH, RX E TEMPERATURA INCLUDE • PH, RX AND TEMPERATURE PROBES INCLUDED)



CAMPO DI UTILIZZO

Per piscine private con strumento multiplo integrato: pH, Temperatura e a richiesta Rx. Adatto per il dosaggio del correttore acido o alcalino in funzione della lettura del pH e per il dosaggio a tempo del disinfettante (es. Perossido di idrogeno) in funzione della temperatura dell'acqua della piscina. Disponibile anche con strumento integrato per la lettura del potenziale Rx per dosaggio proporzionale del cloro.



DESCRIZIONE

Pompa peristaltica tripla integrata con **timer e strumento pH, Temperatura e Redox** (solo modello T-pH-Rx).

- Dosaggio proporzionale di correttore Acido/Alcalino
- Dosaggio temporizzato di 1-2 prodotti per la disinfezione della piscina con compensazione della quantità dosata in funzione della temperatura
- Dosaggio proporzionale al potenziale Redox di disinfettante (solo modello T-pH-Rx)
- Display con controlli digitali
- Allarmi acustici
- Password di protezione
- Predisposizione per sonde livello
- Sensore di flusso
- Connessione alla pompa di ricircolo per consenso al dosaggio (V1)
- Range di misura 5-9pH, 0-999mV.
- Alimentazione 220-230V 50/60Hz

Completa di kit e accessori per una corretta installazione.

Composizione corredo:

- Tubo aspirazione/mandata
- Staffa fissaggio a parete e tasselli
- Elettrodi pH Temperatura e Rx (solo modello con Rx)
- Soluzioni tampone
- Collari portasonda
- Valvole iniezione
- Filtri di fondo.



CARATTERISTICHE TECNICHE/TECHNICAL FEATURES

Codice Code	Modello Model	Sonde Probes	Portata (l/h) Flow Rate (l/h)	Pressione (bar) Pressure (bar)	Tubo Pipe	Dimensione (mm) Size (mm)	Imballo singolo (mm) Single packaging (mm)	Kg Kg	Watt Watt
AD5000G0G000A100	Technopool 3 T-PH-T	TEMP-PH	1,4-1,4-1,4	1-1-1	4 x 6	305x250x160	423 x 277 x 105	3,5	25
AD4600G0G000A100	Technopool 3 T-PH-RX	TEMP-PH-RX	1,4-1,4-1,4	1-1-1	4 x 6	305x250x160	423 x 277 x 105	3,5	25



NORMATIVE

- n° 2004/108/CE Direttiva EMC
- n° 2006/95/CE "DBT Low Voltage Directive"
- n° 2011/65/UE , 2002/96/CE "direttive RoHS e WEEE"

Pompa Peristaltia tripla

TECHNOPOOL 3

Triple peristaltic pump

TECHNOPOOL 3



DIMENSIONI/DIMENSIONS

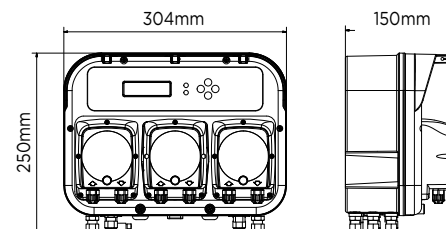

IMBALLO/PACK

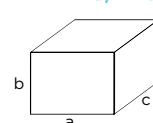

Confezione singola/Single pack:
axbxc: 390x445x165 mm - Kg: 4,33



CONTEXT OF USE

For private pools with multifunctional built-in tool: pH, Temperature and Rx (upon request). Suitable for the dosing of acid/alkaline corrector depending on the pH reading, and for the timed dosing of the disinfectant (like Hydrogen peroxide) depending on water temperature. Also available with the built-in Rx potential reading tool, for a proportional dosing of chlorine.



DESCRIPTION

Triple peristaltic pump with built-in **timer and pH, Temperature and Redox instruments** (T-pH-Rx model only).

- Acid/Alkaline corrector proportional dosing
- Timed dosing of 1-2 disinfectant products whose quantity is compensated depending on the temperature
- Disinfectant dosing proportioned to the Redox potential (T-pH-Rx model only)
- Display with digital controls.
- Acoustic alarms
- Protection password
- Level probes compatible
- Flow sensor
- Connection to the recirculation pump to allow the dosing (V1)
- Measurement range 5-9 pH, 0-999 mV.
- Power supply 220-230V 50/60Hz

With kit and equipment for a correct installation.

The equipment consists of:







- Suction/injection pipe
- Wall fixing bracket and dowels
- pH, temperature and Rx electrodes (Rx model only)
- Buffer solutions
- Probe holder collars
- Injection valves
- Foot filters.







STANDARDS

- no. 2004/108/CE EMC directive
- no. 2006/95/CE "DBT Low Voltage Directive"
- n° 2011/65/UE , 2002/96/CE "RoHS and WEEE directives"

KIT DI INSTALLAZIONE/INSTALLATION KIT

	Codice/Code	Descrizione/Description
	ADPSTC	Porta sonda ad iniezione 2in1 2in1 injection probe holder
	ADSTS100N	Sonda di temperatura PT100 PT100 Temperature probe
	ADELTPH05	Elettrodo pH con cavo 5mt pH electrode with 5 m cable
	ADELTRX05	Elettrodo Rx con cavo 5mt (Solo mod. Rx) RX electrode with 5 m cable (only Rx mod.)
	ADSP6000551	Tubo in PVC Ø 4x6 4mt (x2-x3) PVC pipe Ø 4x6 4 m (x2-x3)
	ADSP6020156	Staffa di fissaggio a parete Wall fixing bracket

	Codice/Code	Descrizione/Description
	ADSP6000001	Filtro di fondo 4x6 (x2-x3) Foot filter 4x6 (x2-x3)
	ADSP6000593	Punta conica per foratura Ø24 Drilling tip cone Ø24
	ADSPH4 ADSPH7	Soluzione tampone pH4 e pH7 pH4 and pH7 buffer solutions
	ADSRX	Soluzione tampone mV 475 (Solo mod. Rx) mV 475 buffer solution (only Rx mod.)
	ADSP6000041	Tasselli e viti Wall plugs and screws

RICAMBI/ SPARE PARTS



Codice/Code	Modello/Model	Portata (l/h) Flow Rate (l/h)	Pressione Pressure	Tubo Pipe
ADSP8000109N	Tubo ricambio Isipool - Technopool - Litepool / Isipool - Technopool - Litepool spare pipe	1,4 - 3	1	4 x 6

+ OPTIONAL/ OPTIONAL



Codice/Code	Modello/Model
ADSLG	Sonda livello con connettore (opzionale) / Level probe with connector (optional)



Codice/Code	Modello/Model	Dimensione (Øxh) Size (Øxh)	Volume (l/h) Volume (l/h)
ADTANK010	Serbatoio polietilene/ PE tank	500 x 680	100 L
ADTANK020	Serbatoio polietilene/ PE tank	620 x 800	200 L
ADTANK030	Serbatoio polietilene/ PE tank	710 x 890	300 L

ESEMPIO DI INSTALLAZIONE/ INSTALLATION EXAMPLE

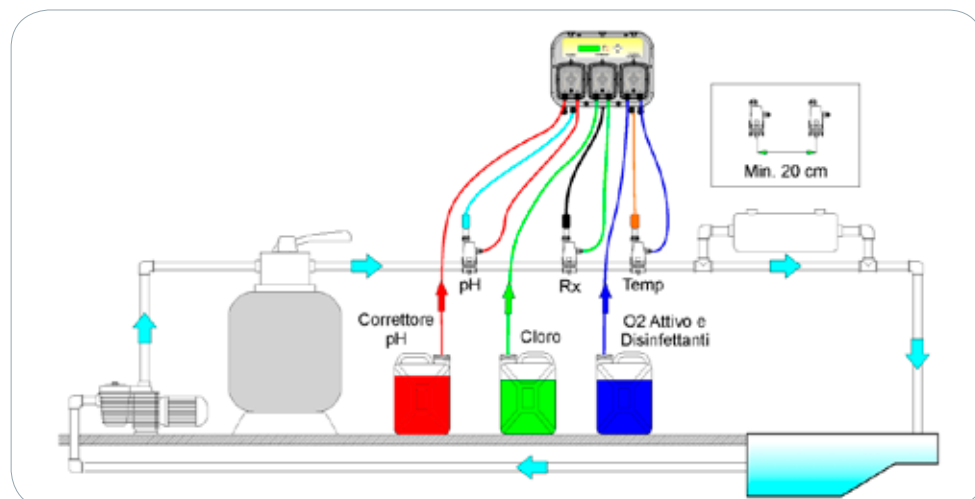

QR code
Vai direttamente
all'approfondimento
Get more detailed
information